

# P.R. 122 B "Coupe" ①

Ref. 60 00 007 261

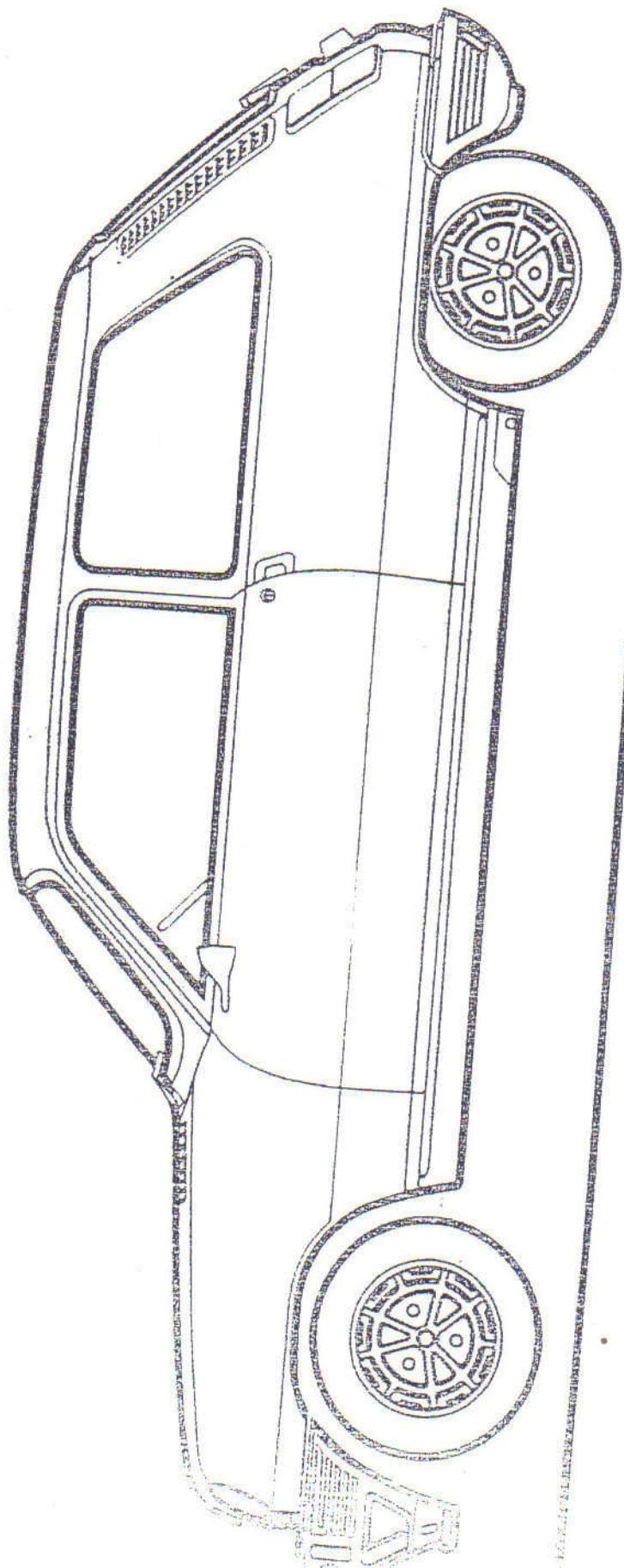

RENAULT 5 ALPINE Turbo "Coupe"

60 00 061 088  
60 00 061 089

# P.R. 122 B Coupe

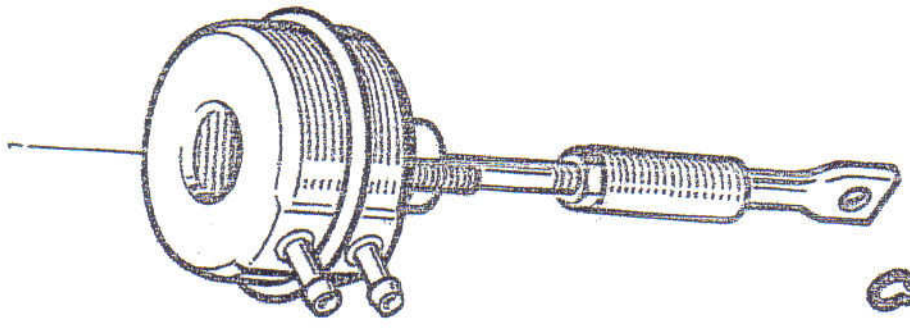
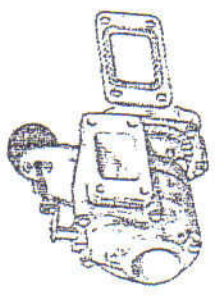

P.R. 122 B Coupe

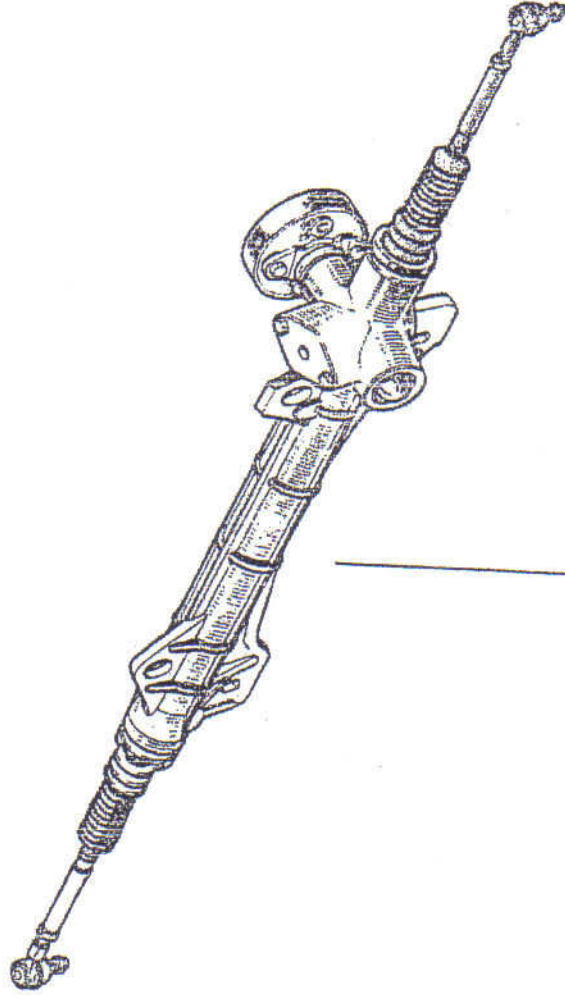

# P.R. 122 B "Coupe"

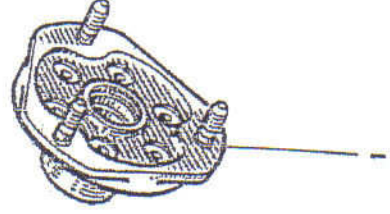
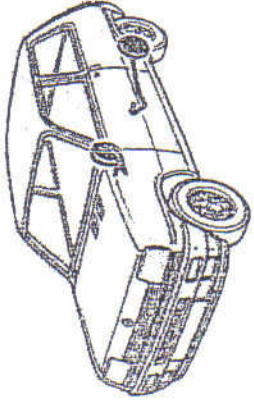

# P.R. 122 B "Coupe"

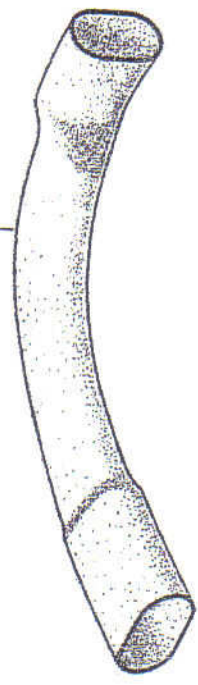
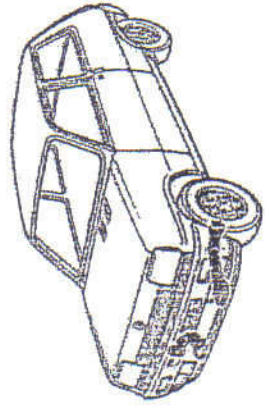

- 77 01 021 773
- 77 01 020 207
- 77 03 001 123
- 79 03 056 039

# P.R. 122 B Coupe

- 1 77 01 460 708
- 2 77 01 022 735
- 3 77 01 460 709

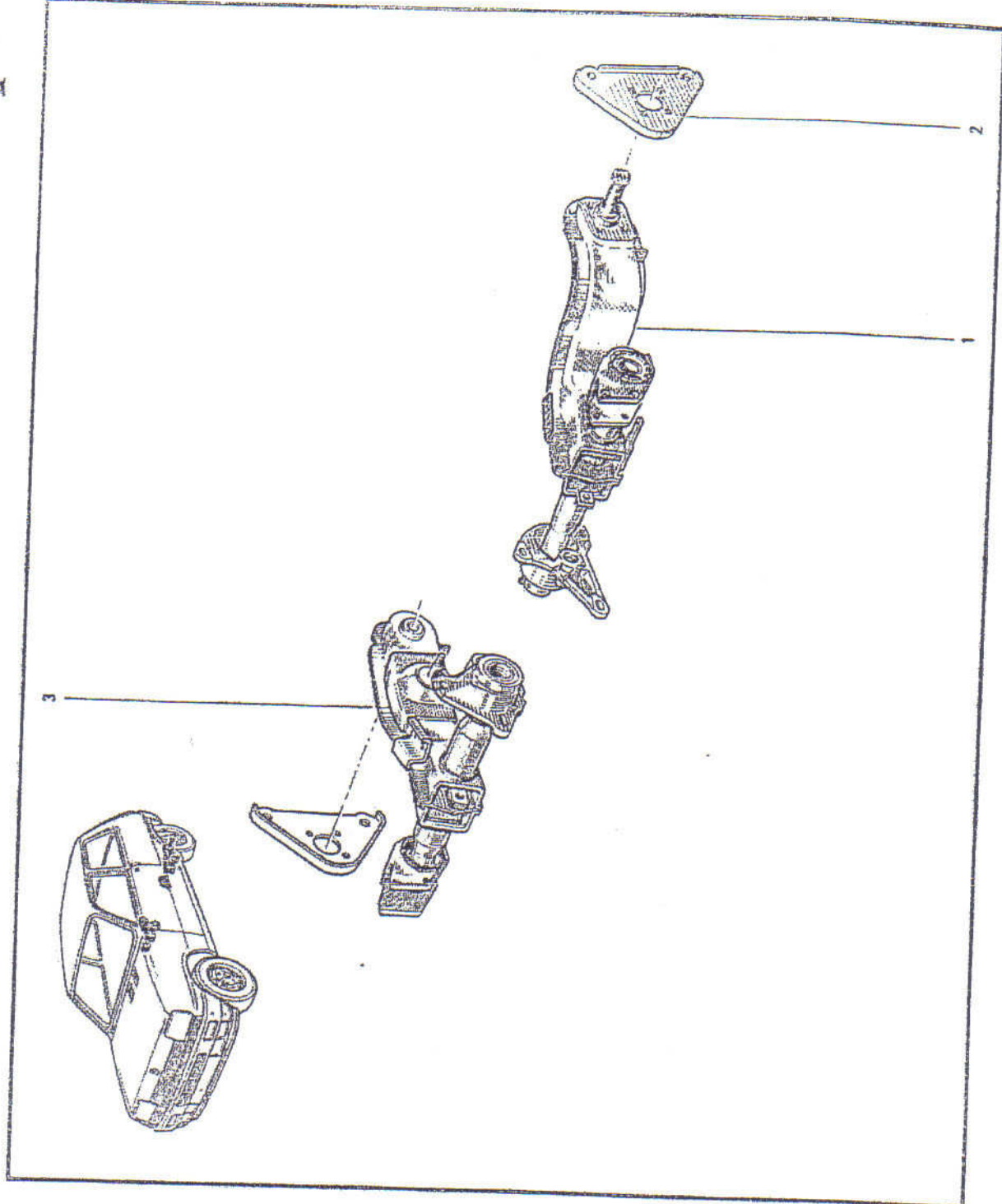

# P.R. 122 B "Coupe"

- 1 77 00 649 788
- 2 77 00 638 414
- 3 77 01 021 766
- 4 77 00 649 709
- 5 77 00 638 415

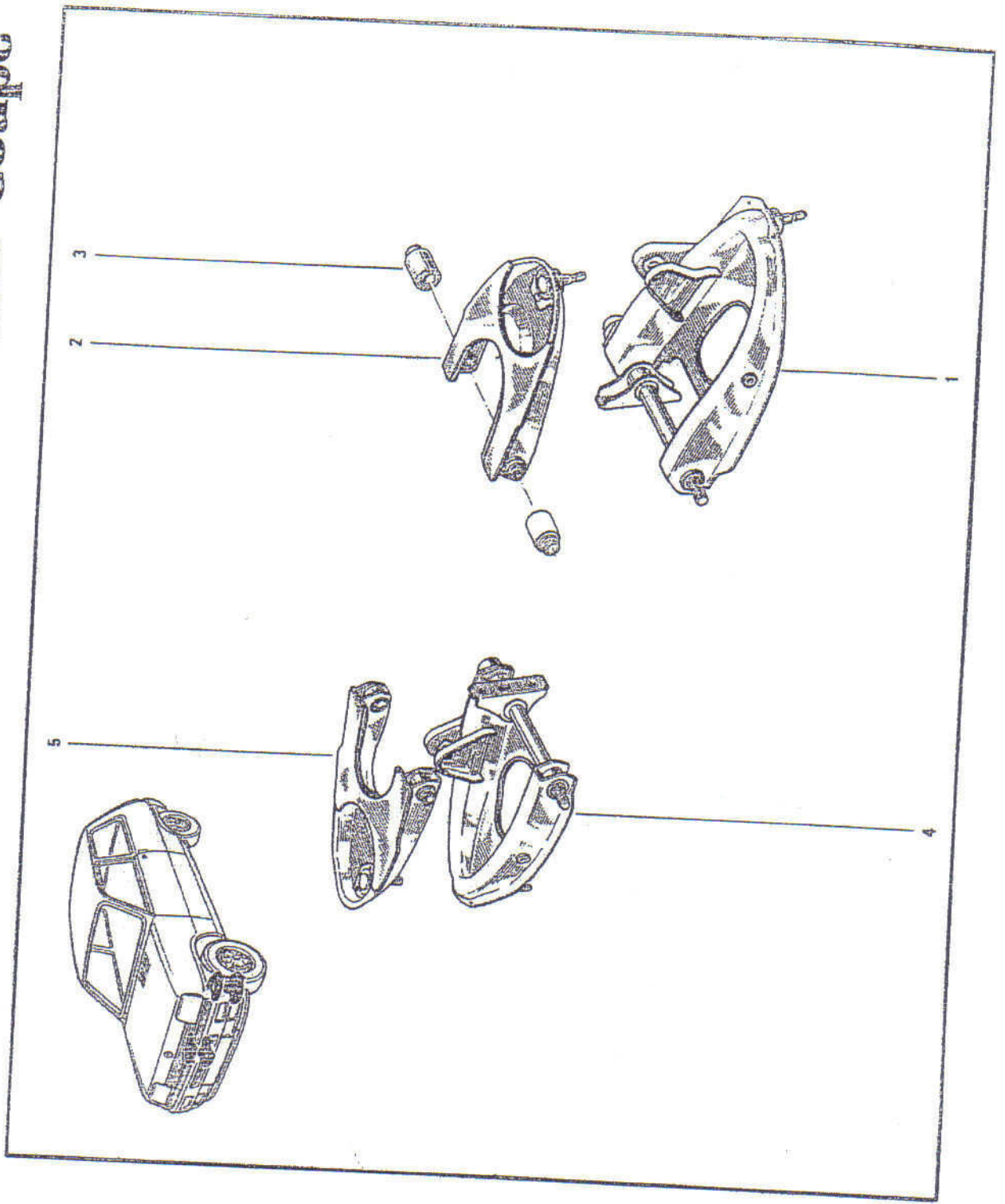

# P.R. 122 B Coupe

- 1 77 00 619 036
- 2 77 00 616 267
- 3 60 00 057 098
- 4 60 00 056 681
- 5 77 00 616 396

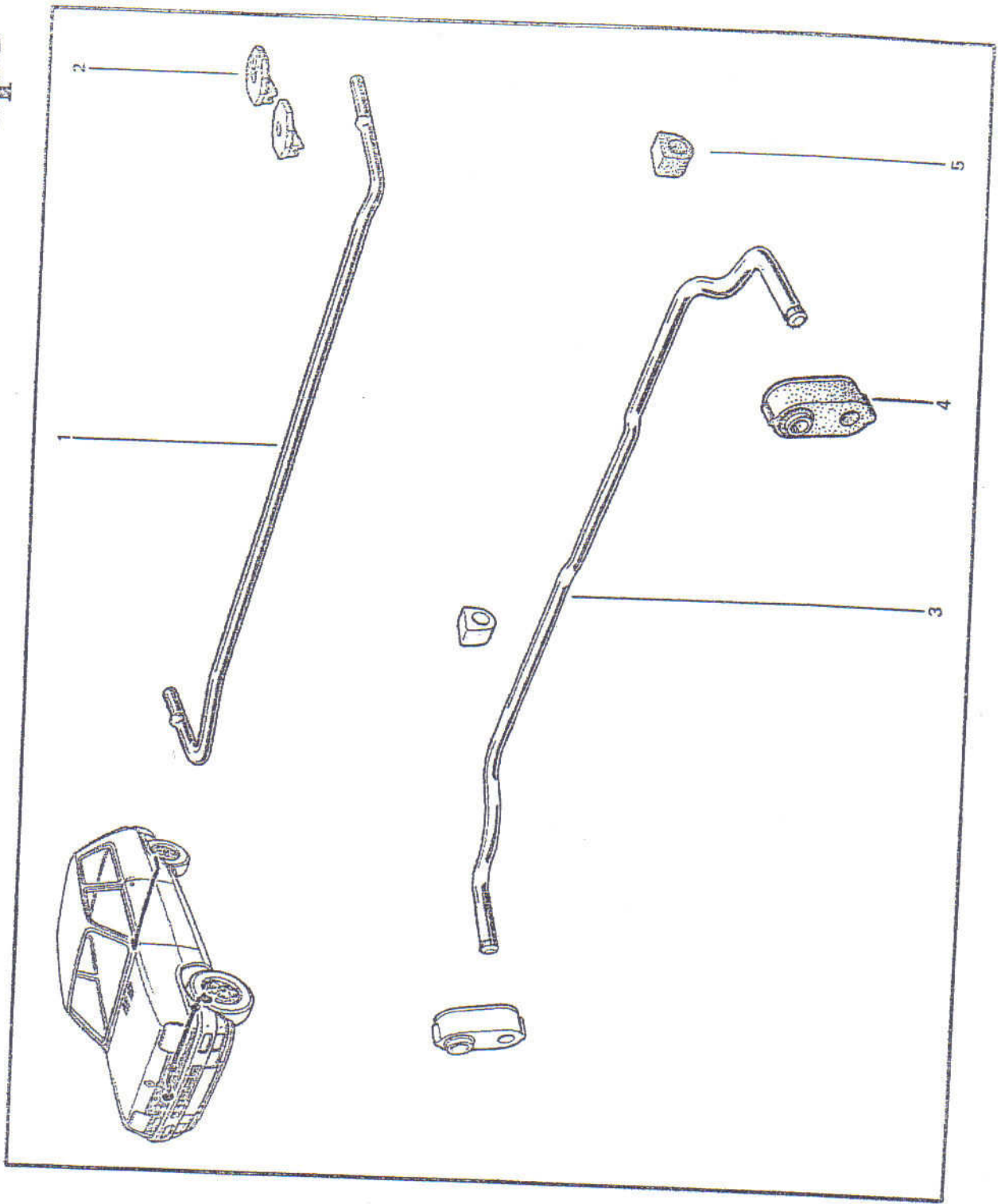



# P.R. 122 B Coupe

- 1 77 01 022 733
- 2 77 00 565 712
- 3 77 00 534 083
- 4 77 00 618 233

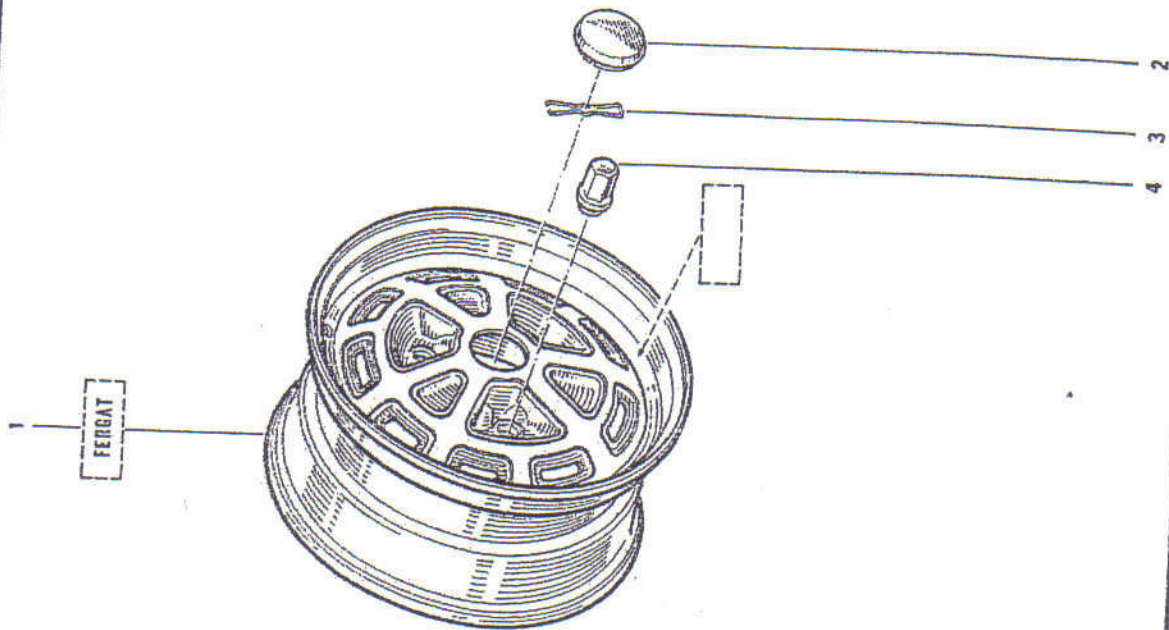

# P.R. 122 B "Coupe"

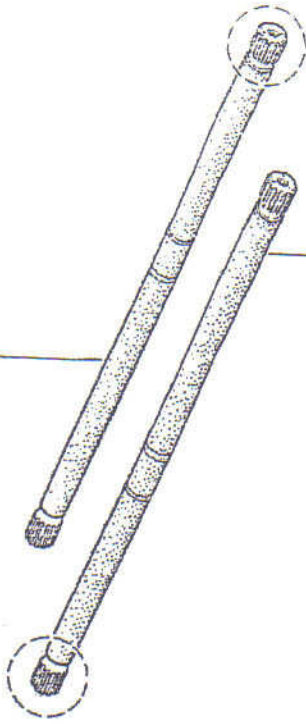
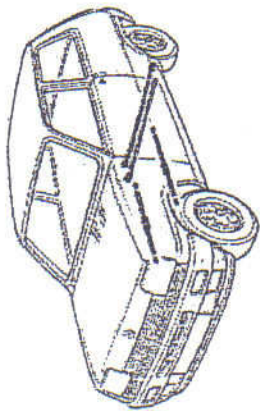

2

# P.R. 122 B "Coupe"

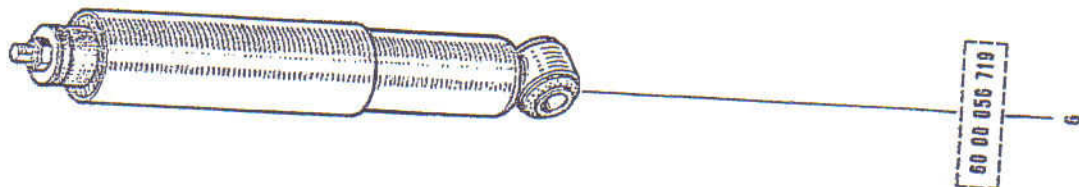
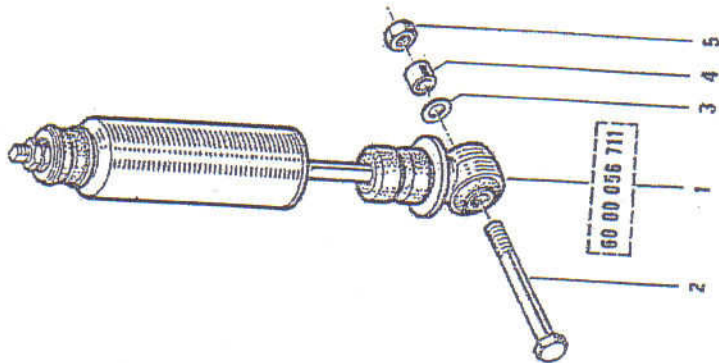
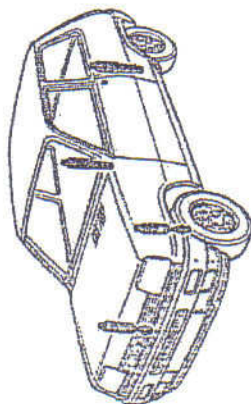

- 1 77 01 021 800
- 2 77 03 001 198
- 3 77 03 053 066
- 4 77 01 021 879 ou 60 00 056 682
- 5 77 03 034 003
- 6 77 01 021 765

# P.R. 122B "Coupe"

77 01 021 852  
77 01 021 853  
00 00 056 562

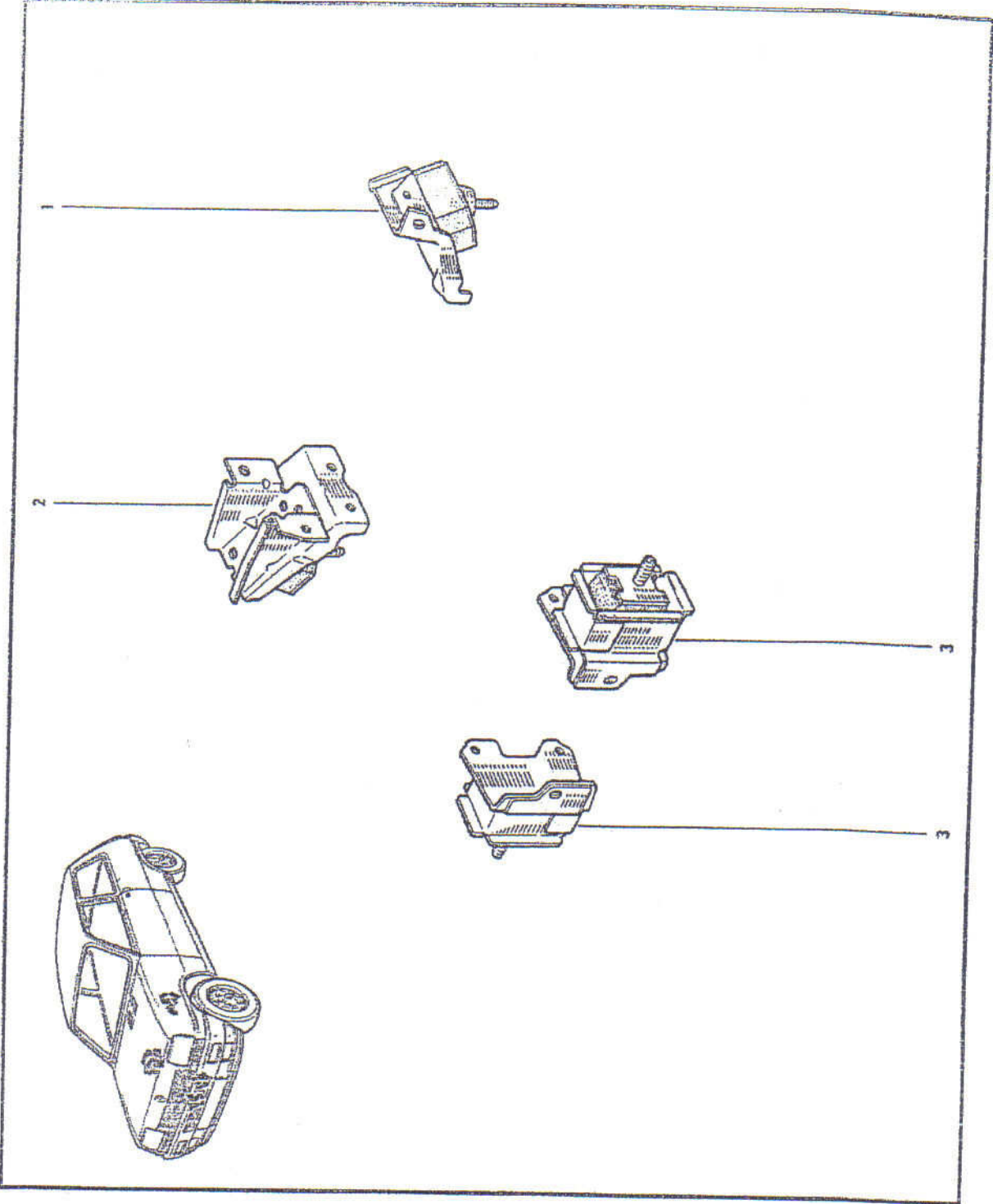

# P.R. 122 B "Coupe"

1 77 00 636 714

2 77 01 011 576

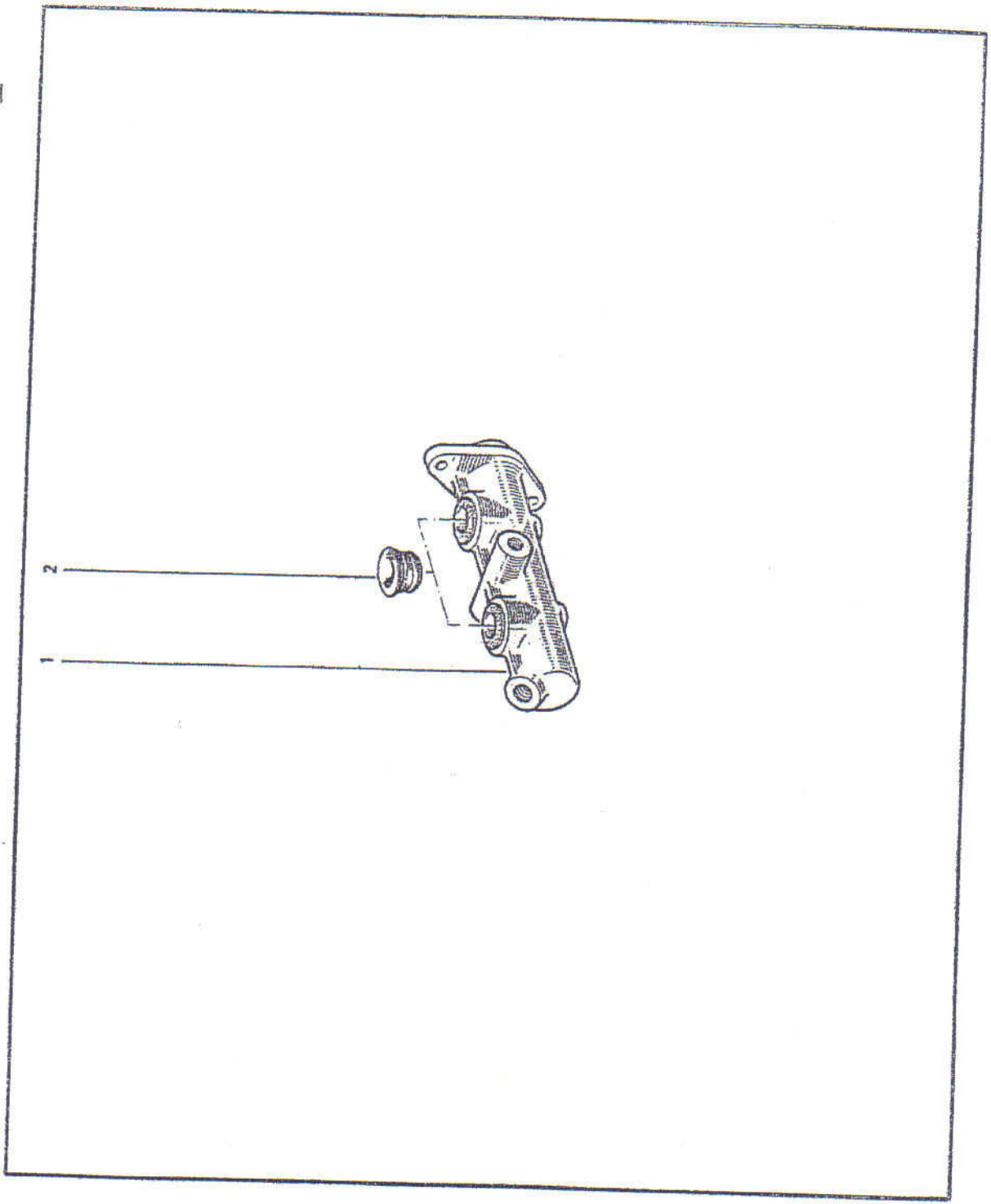

P.R. 122 B "Coupe"

60 00 061 090

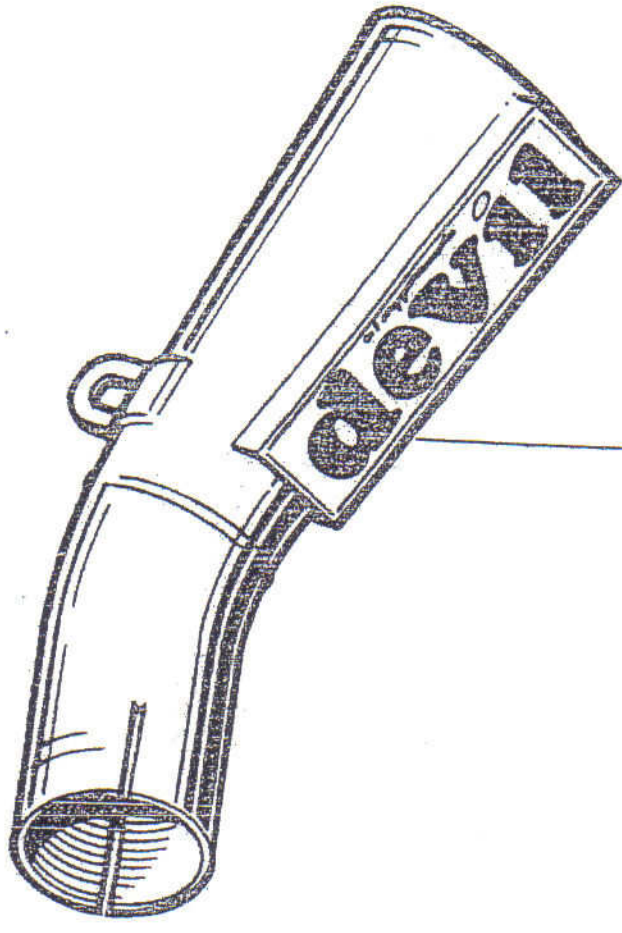

P.R. 122 B "Coupe"

DU 22 989 600

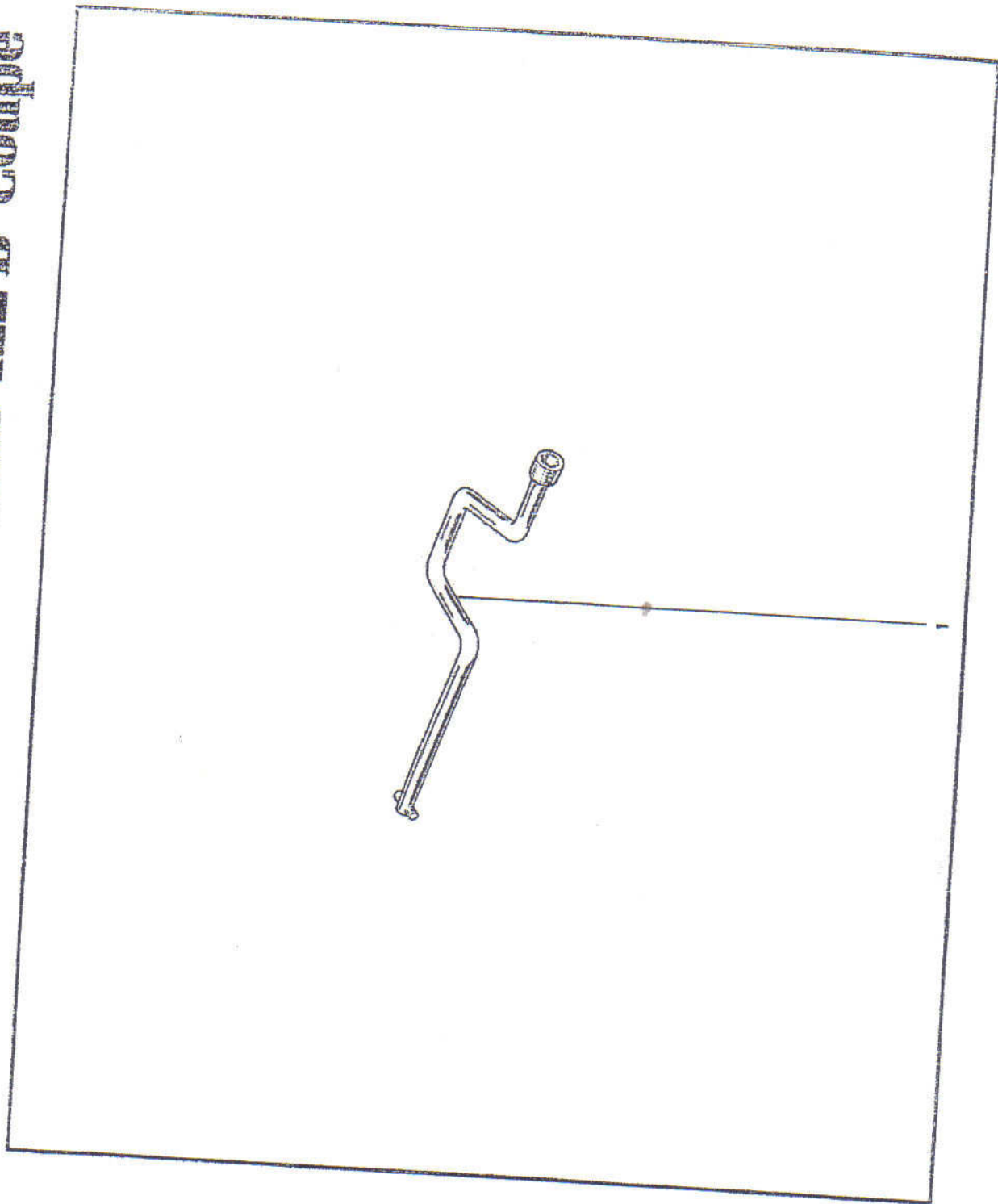

# P.R. 122B Coupe

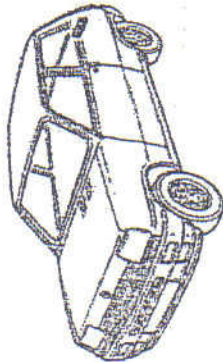

Coupe



# P.R. 122 B "Coupe"

